

# PLATINUM JOHN

## INSTALLATION MANUAL

### TOILET PAPER HOLDER WITH STORAGE SHELF

PJ01005-02

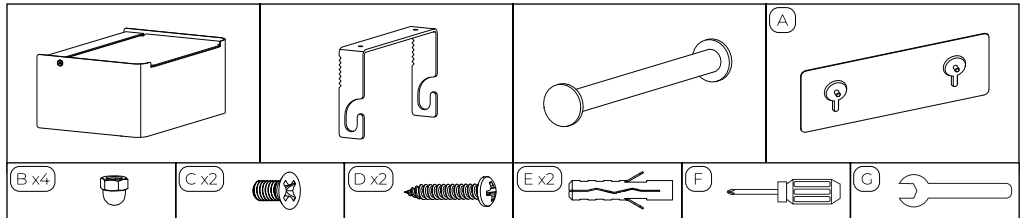
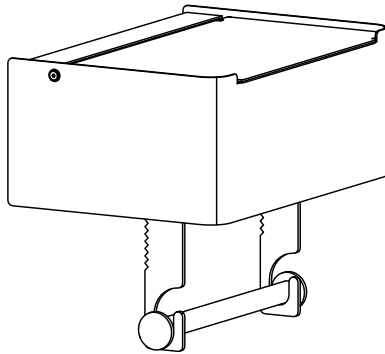

(1a) No Drill Adhesive Anchors (Only for very smooth and unpainted surfaces) (A x1) (B x2) (G)  
Clean wall surface, peel off adhesive backing and stick firmly onto the wall. Wait 24 hours, then attach the storage shelf.

(1) Choose Wall Anchors

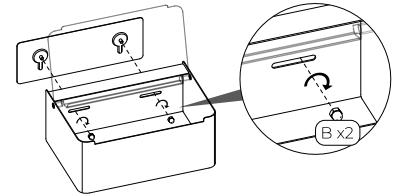
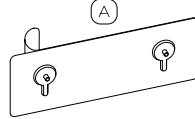

(1b) Drilled Anchors (D x2) (E x2) (F)  
Mark and drill anchor holes, insert wall anchors, then attach the storage shelf.

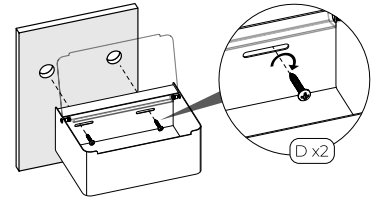
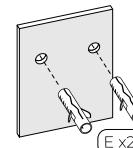
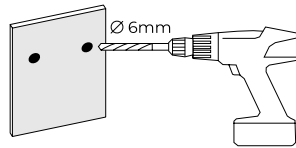

(2) Toilet Paper Holder Assembly (B x2) (C x2) (F) (G)  
Screw the hook onto the shelf, then place the rod in the hook. Toilet paper MUST be pulled from behind to use tear teeth.

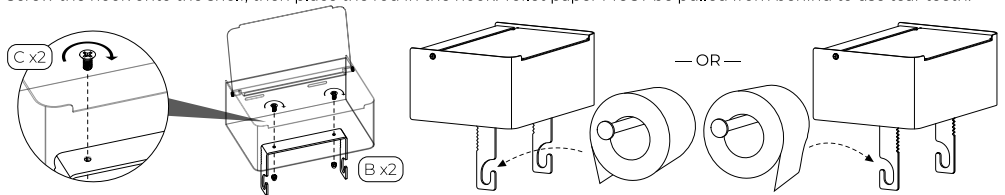

—OR—

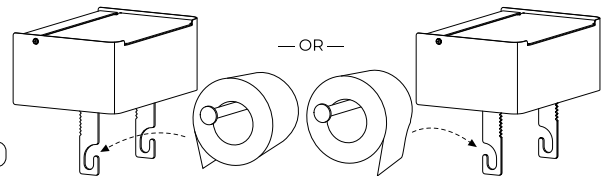

@platinumjohnstore  
<https://platinumjohn.com>